

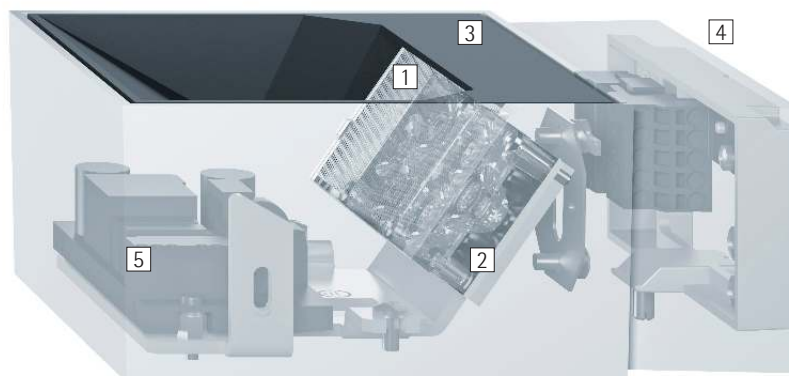

Pantrac – Lighting effects for ceilings

This ceiling washlight makes the task of creating uniform uplighting incredibly easy
Pantrac wall-mounted luminaires focus on adding lighting effects to ceilings. The luminaires bring out the support structure and lend rooms a higher appearance. Ceilings decorated with stucco and paintings are given a new dimension. Pantrac blends into its architectural surroundings. The archetypal cubic design remains unobtrusive letting the luminaire recede into the background. The luminaire is available in different sizes with a range of light

distribution patterns. This ensures optimum illumination of the ceiling with a minimum number of luminaires. In this way, Pantrac represents not only an effective, but also a cost-efficient, lighting solution.



Structure and characteristics

The features described here are typical of products in this range. Special versions may offer additional or varying features. A comprehensive description of the features of individual products can be found on our website.

1 ERCO Spherolit lens

- Light distributions: wide beam or deep beam

2 ERCO LED-module

- High-power LEDs: warm white (2700K or 3000K) or neutral white (3500K or 4000K)
- Collimating lens made of optical polymer

3 Cover frame

- Polymer, black lacquered

4 Housing and wall plate

- White (RAL9002)
- Cast aluminium, powder-coated

5 Control gear

- Switchable, phase dimmable or DALI dimmable
- Phase dimmable version: Dimming with external dimmers possible (trailing edge)

Variants on request

- Housing: 10,000 further colours
- Please contact your ERCO consultant.



Design and application:
www.erco.com/pantrac-w

Pantrac Wall-mounted luminaires



Outstanding uniformity
To meet the stringent standards of ceiling washing, ERCO has developed luminaires that generate exceptionally uniform levels of illuminance.





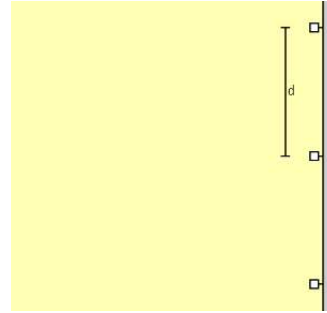

Wide or deep beam distribution
The wide or deep beam distribution Spherolit lenses allow the light distribution to be matched to the lighting task at hand.



Wide luminaire spacing with ceiling washlighting
ERCO's efficient photometrics enable selected luminaires to be spaced particularly far apart, thereby minimising the number of luminaires required.

Special characteristics

-  Different light distributions: wide or deep
-  Outstanding uniformity
-  Wide luminaire spacing with ceiling washlighting

 ERCO high-power LEDs

 Efficient Spherolit technology

 Different light colours

 Excellent thermal management

 EMC-optimised

 Various construction sizes

 Switchable

 Phase dimmable

 DALI dimmable

Pantrac Wall-mounted luminaires – Luminaire arrangement

Ceiling washlights
Wide beam, Deep beam

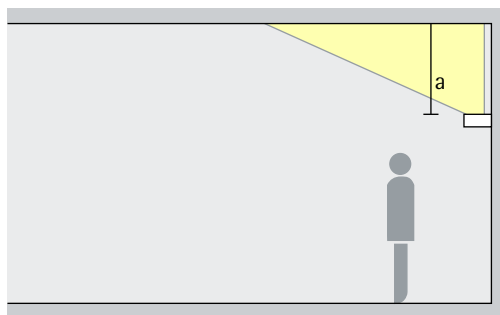

General lighting

Illuminated ceilings produce a high and spacious impression of the room. The distance of Pantrac to the ceiling depends on the design criteria, but should not be less than 0.8m. In rooms with a ceiling height of 3m, this corresponds roughly to the height of the door frame.

Arrangement: $a > 0.8\text{m}$

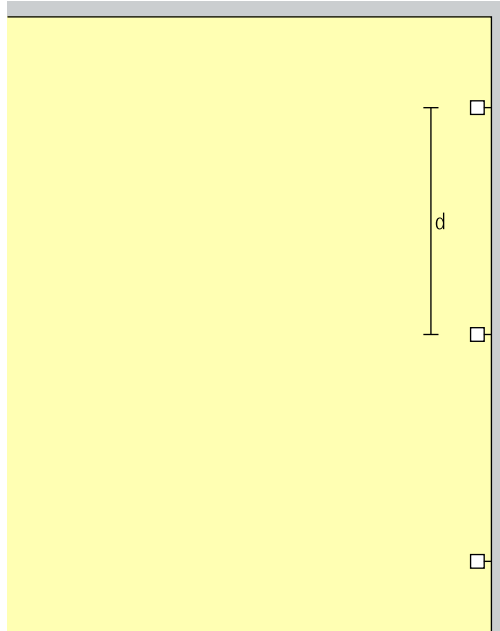

The distance (d) of luminaires with wide beam light distribution may be up to 4 times the ceiling offset (a).

Arrangement: $d = 4 \times a$

The distance (d) of luminaires with deep beam light distribution may be up to 3 times the ceiling offset (a).

Arrangement: $d = 3 \times a$

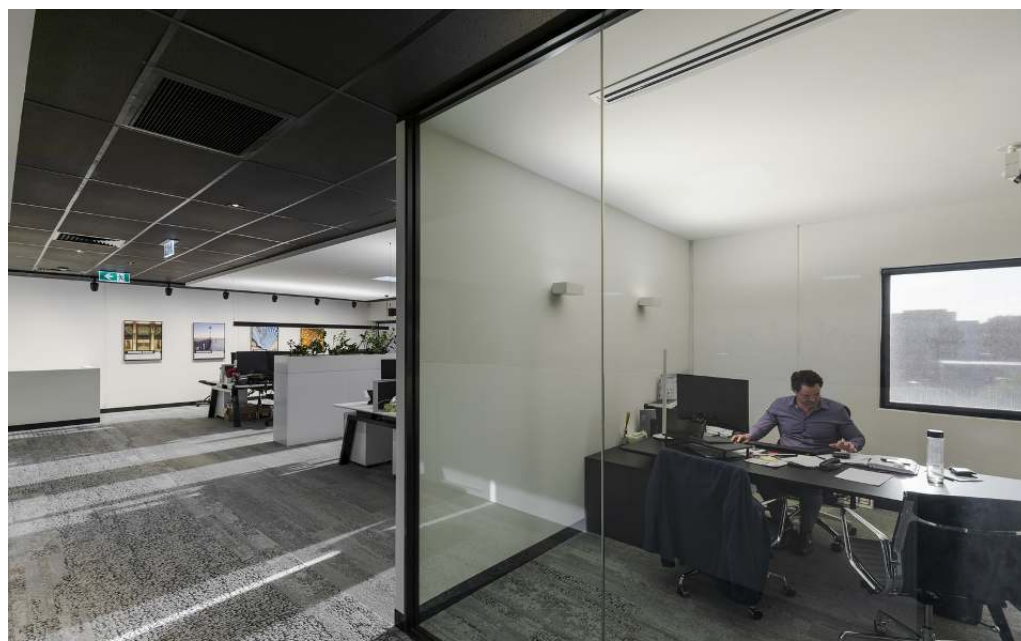

Buckford Illumination Group, Melbourne. Architecture and lighting design: Buckford Illumination Group. Photography: Jackie Chan, Sydney.

Pantrac Wall-mounted luminaires

Construction size 119mm

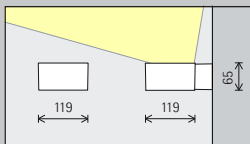

LED module
Maximum value
at 4000K CRI 82

12.1W/1572lm

Light colour

	2700K CRI 92		3500K CRI 92
	3000K CRI 92		4000K CRI 82
	3000K CRI 97		4000K CRI 92

Light distribution

	Ceiling washlights
	Wide beam
	Deep beam

Control

	Switchable
	Phase dimmable
	DALI

Colour (housing)

	White
	10,000 colours *

208mm

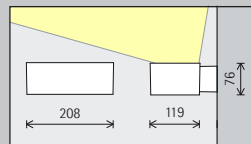

24.3W/3144lm

	2700K CRI 92		3500K CRI 92
	3000K CRI 92		4000K CRI 82
	3000K CRI 97		4000K CRI 92

	Ceiling washlights
	Wide beam
	Deep beam

	Switchable
	Phase dimmable
	DALI

	White
	10,000 colours *



* available on request

Article numbers and planning data:
www.erco.com/014692

Design and application:
www.erco.com/pantrac-w



