



Iku – Efficient, economical, universal

Downlights and wallwashers for architectural lighting

Five sizes and five light distributions enable perfect, economical lighting for applications of all dimensions: in large public buildings, offices and conference centres, but also in smaller rooms in the restaurant and hotel sector. Iku enables large luminaire spacing with wide light distributions thanks to oval light beams. Iku wallwashers and double wallwashers enhance rooms and corridors with visual width and increase the impression of brightness. Iku is characterised by high luminous

efficacy and a long service life. The combination of tunable white, different light distributions and modern connectivity creates lighting in the sense of Human Centric Lighting.

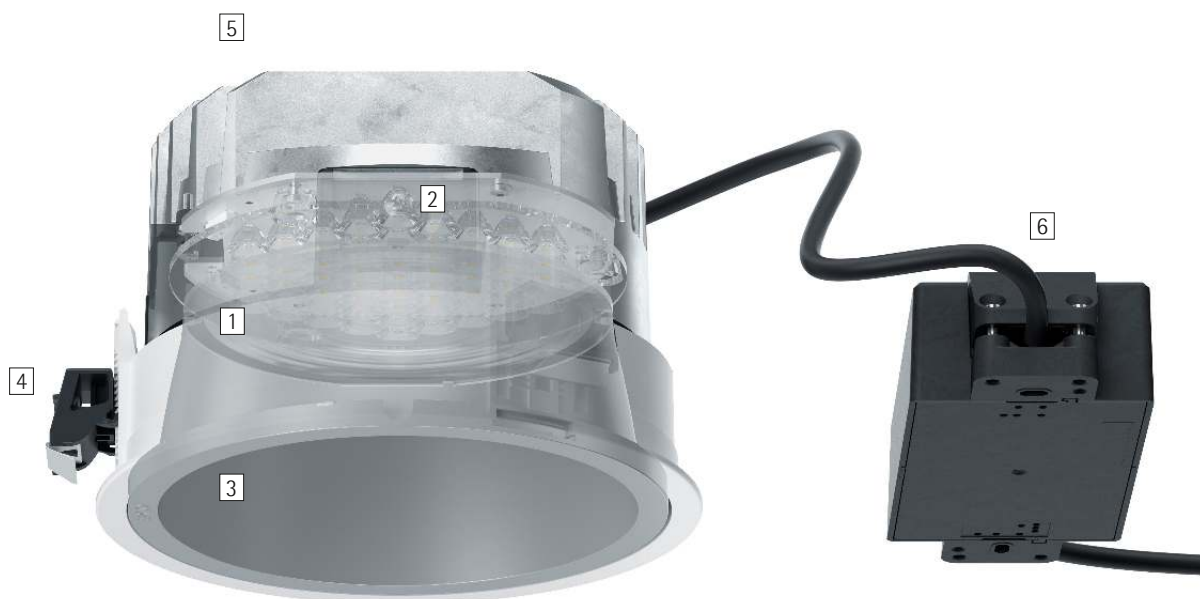

Structure and characteristics

The features described here are typical of products in this range. Special versions may offer additional or varying features. A comprehensive description of the features of individual products can be found on our website.

1 ERCO lenses

- Made of optical polymer
- Fresnel lenses: Wide flood, Extra wide flood or Oval flood
- Lens system: Wallwash or Double wallwash
- Oval flood 360° rotation

2 ERCO LED-module

- Mid-power LEDs (downlights) or High-power LEDs (wallwashers): warm white (2700K or 3000K), neutral white (3500K or 4000K) or Tunable white (2700-6500K)
- Downlights: collimating lens made of optical polymer

3 Anti-glare cone

- Silver-coated or black

4 Mounting ring

- Covered mounting detail
- Fixing for ceiling thicknesses of 1-25mm (size 2-4) or 1-30mm (size 5-7)
- Polymer, white
- Ceiling-flush mounting detail (size 2): mounting for 12.5-25mm ceiling thicknesses.
- For ceiling-flush mounting (sizes 3-7): mounting ring to be ordered separately, fixing for ceiling thicknesses of 12.5-25mm

5 Housing

- Cast aluminium, designed as heat sink
- Rotatable through 360°

6 Control gear

- Switchable, DALI dimmable or Casambi Bluetooth

Variants on request

- Anti-glare cone: gold matt, silver matt, champagne matt or copper matt-coated and other colours
- Connection: 3- or 5-pole plug with connection cable (Wago or Wieland)
- Mounting ring: 10,000 further colours

Please contact your ERCO consultant.



Design and application:
www.erco.com/iku

Iku Recessed luminaires



Elegant light emission
The special geometry of the lens ensures a uniformly illuminated light opening with high visual comfort.

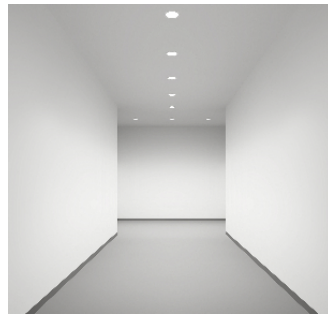

Double wallwasher
The special light distribution of the double wallwashers efficiently illuminates the opposite walls of corridors. The diffuse, reflected light from the walls also illuminates the floor and ceiling.



Tunable white technology
Just as the colour temperature outdoors changes continuously during the day, the colour temperature of indirect lighting can be adjusted indoors to e.g. support lighting concepts for Human Centric Lighting.



Covered or flush mounting detail
Recessed downlights have covered mounting rings. Flush mounting rings are available as accessories. Size 2 recessed downlights are optionally available in a covered or flush version.

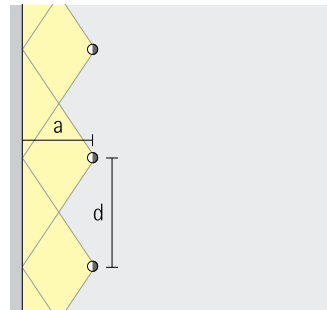

Wide luminaire spacing with wallwashing
Efficient ERCO photometrics allow certain luminaires to be spaced unusually far apart at up to 1.5 times the distance to wall.

Special characteristics



Elegant light emission



ERCO Mid-power LEDs / ERCO High-power LEDs



Excellent thermal management



Switchable



Double wallwasher



Different light distributions



Various construction sizes



Casambi Bluetooth



Tunable white



Oval flood, freely rotatable



Lockable



Flush or covered mounting detail



Different light colours



Tool-free mounting



Wide luminaire spacing with wallwashing

Iku Recessed luminaires – Luminaire arrangement

Downlights

Wide flood, Extra wide flood

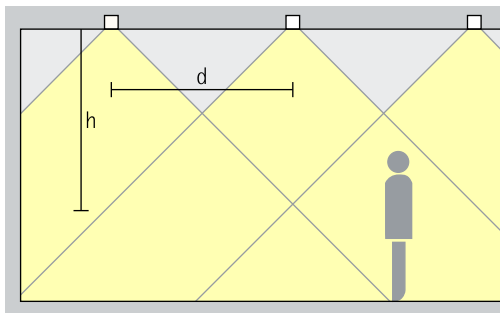

General lighting

For uniform general lighting with high visual comfort, the luminaire spacing (d) between two Iku downlights may be up to 1.5 times the height (h) of the luminaire above the working plane (rough guide).

Arrangement: $d = 1.5 \times h$

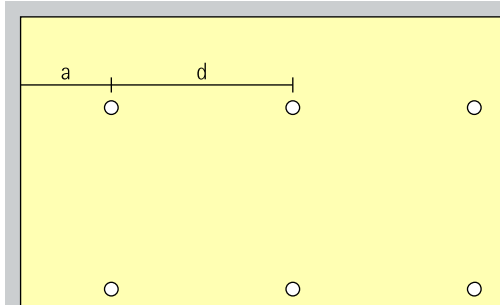

The wall offset should be half the luminaire spacing.

Arrangement: $a = d / 2$

Downlights oval flood

Oval flood

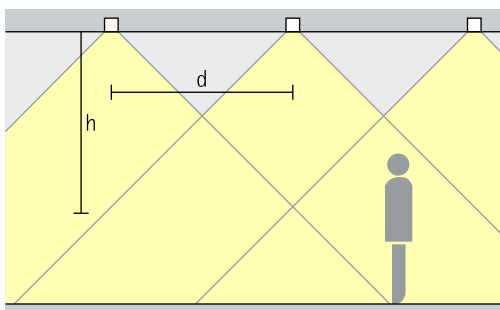

Linear lighting

For linear arrangements and uniform lighting, the luminaire spacing (d) between two Iku downlights may be up to 1.5 times the height (h) of the luminaire above the working plane (rough guide).

Arrangement: $d = 1.5 \times h$

Application area: corridors and circulation areas.

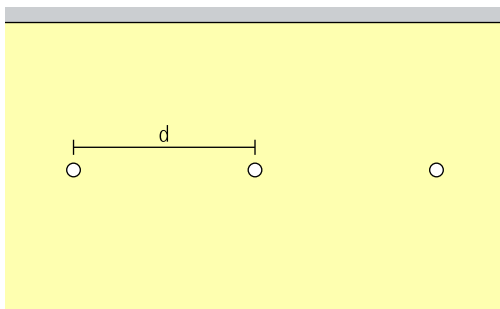

Iku Recessed luminaires – Luminaire arrangement

Lens wallwashers Wallwash

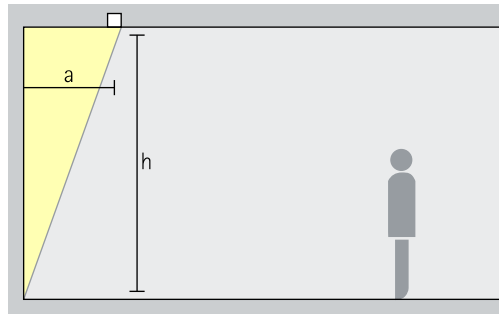

Wallwashing

For uniform vertical lighting, the distance to the wall (a) of Iku wallwashers should be around one third of the room height (h).

Arrangement: $a = 1/3 \times h$

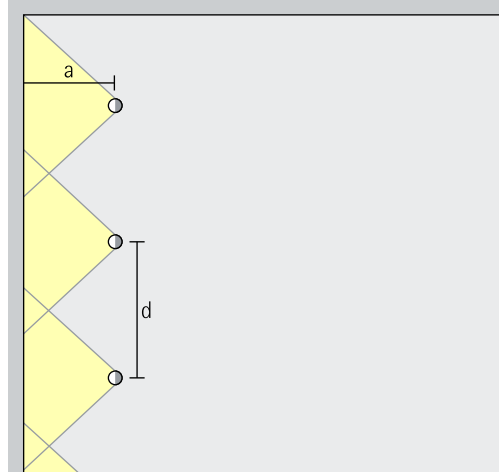

For good longitudinal uniformity, the luminaire spacing (d) of Iku wallwashers may be up to 1.3 times the distance to the wall (a).

Arrangement: $d \leq 1.3 \times a$

Optimal wall distances and luminaire spacing values for individual products are specified in the wall-washer tables.

Double wallwashers Double wallwash

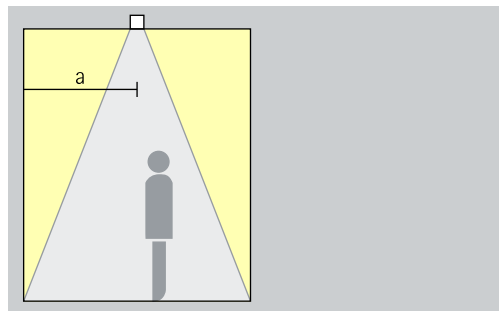

Wallwashing

For the uniform vertical lighting of opposite walls, the distance to the wall (a) on both sides with Iku double wallwashers should be around one third of the room height (h). The luminaires should always be positioned on the central axis between the walls.

Arrangement: $a = 1/3 \times h$

Application area: Corridors, e.g. in administrative and healthcare buildings

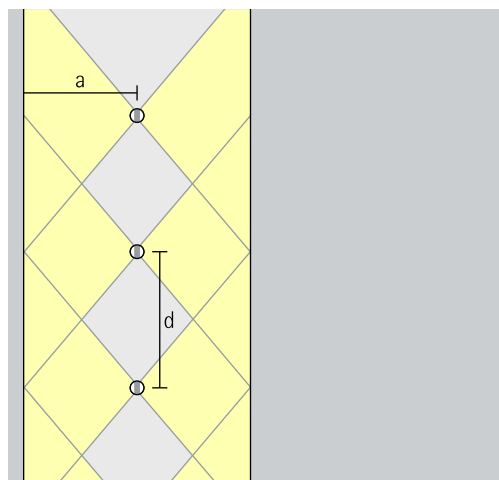

For good longitudinal uniformity, the luminaire spacing (d) of Iku wallwashers may be up to 1.3 times the distance to the wall (a).

Arrangement: $d \leq 1.3 \times a$

Optimal wall distances and luminaire spacing values for individual products are specified in the wall-washer tables.

Iku Recessed luminaires

Construction size

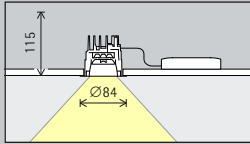

Size 2

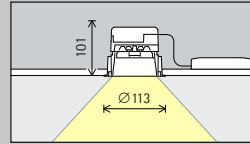

Size 3

LED module
Maximum value at 4000K CRI 82

3.1W/529lm

8.8W/1492lm

Light colour

	2700K CRI 92		3500K CRI 92
	3000K CRI 82 **		4000K CRI 82
	3000K CRI 92		4000K CRI 92
	3000K CRI 97 ***		

	2700K CRI 92		3500K CRI 92
	3000K CRI 82 **		4000K CRI 82
	3000K CRI 92		4000K CRI 92
	3000K CRI 97 ***		

Light distribution

Downlights		Downlights oval flood	
	Wide flood		Oval flood
	Extra wide flood		Lens wallwashers
			Wallwash

Downlights		Downlights oval flood	
	Wide flood		Oval flood
	Extra wide flood		Lens wallwashers
			Wallwash

Control

	Switchable
	DALI
	Casambi Bluetooth

	Switchable
	DALI
	Casambi Bluetooth

Colour (anti-glare cone)

	Silver
	Black

	Silver
	Black

Accessories

	Concrete mounting enclosure		Spacer plate		Compensation set
	Mounting ring		Mounting plate for panelled ceilings		Cover ring

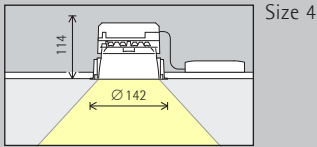

17.7W/2984lm

10.6W/1546lm

	2700K CRI 92		3500K CRI 92
	3000K CRI 82 **		4000K CRI 82
	3000K CRI 92		4000K CRI 92
	3000K CRI 97 ***		

Tunable white

Downlights		Lens wallwashers	
	Wide flood		Wallwash
	Extra wide flood	Double wallwashers	
	Downlights oval flood		Double wallwash
	Oval flood		

Downlights		Downlights oval flood	
	Wide flood		Oval flood
	Extra wide flood	Lens wallwashers	
			Wallwash

	Switchable
	DALI
	Casambi Bluetooth

	DALI
	Casambi Bluetooth

	Silver
	Black

	Silver
	Black

** only for wide flood, extra wide flood and oval flood distribution
 *** only for wallwash and double wallwash distribution

Article numbers and planning data:
www.erco.com/020543

Design and application:
www.erco.com/iku



Iku Recessed luminaires

Size

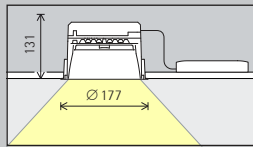

Size 5

LED module
Maximum value at 4000K CRI 82

28.7W/4860lm	17.7W/2577lm
--------------	--------------

Light colour

2700K CRI 92	3500K CRI 92	Tunable white
3000K CRI 82 **	4000K CRI 82	
3000K CRI 92	4000K CRI 92	
3000K CRI 97 ***		

Light distribution

Downlights	Lens wallwashers	Downlights	Downlights oval flood
Wide flood	Wallwash	Wide flood	Oval flood
Extra wide flood	Double wallwashers	Extra wide flood	Lens wallwashers
Downlights oval flood	Double wallwash		Wallwash
Oval flood			

Control

Switchable	DALI
DALI	Casambi Bluetooth
Casambi Bluetooth	

Colour (anti-glare cone)

Silver	Silver
Black	Black

Accessories

Concrete mounting enclosure	Spacer plate	Compensation set
Mounting ring	Mounting plate for panelled ceilings	Cover ring

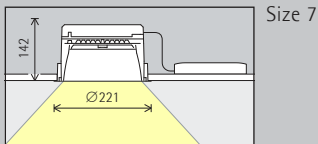

36.7W/6381lm

26.5W/3866lm

	2700K CRI 92		3500K CRI 92
	3000K CRI 82 **		4000K CRI 82
	3000K CRI 92		4000K CRI 92
	3000K CRI 97 ***		

Tunable white

Downlights		Downlights oval flood	
	Wide flood		Oval flood
	Extra wide flood		Lens wallwashers
			Wallwash

Downlights		Downlights oval flood	
	Wide flood		Oval flood
	Extra wide flood		Lens wallwashers
			Wallwash

	Switchable
	DALI
	Casambi Bluetooth

	DALI
	Casambi Bluetooth

	Silver
	Black

	Silver
	Black

** only for Wide flood, Extra wide flood and Oval flood distribution
 *** only for wallwash and double wallwash distribution

Article numbers and planning data:
www.erco.com/020543

Design and application:
www.erco.com/iku



