



Pantrac – Lighting effects for walls

Simple and efficient wallwashing for museums and business premises.

Pantrac exceeds the demands of the ultimate challenge in lighting design: perfect wallwashing. The system is designed to achieve superb uniform illumination of walls, product shelving or exhibits with total visual comfort. Innovative photometrics optimize its efficiency and, as a result, reduce the number of luminaires required, as these can be spaced further apart.

With its archetypal cubic design, the luminaire integrates as effort-

lessly with modern rooms as with historic architecture. A very wide dimming control range of 1% to 100% supports aesthetic and conservation aspects of artwork protection and gallery appearance.

Pantrac for 2-circuit track

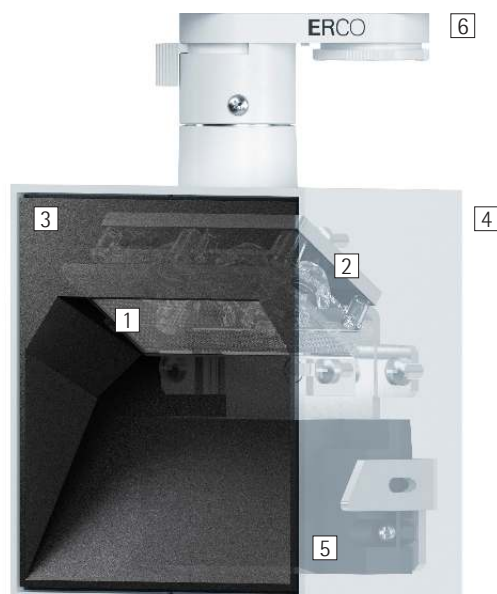

Structure and characteristics

The features described here are typical of products in this range. Special versions may offer additional or varying features. A comprehensive description of the features of individual products can be found on our website.

1 ERCO Spherolit lens

- Light distribution: wallwash

2 ERCO LED-module

- High-power LEDs: warm white (2700K or 3000K) or neutral white (3500K or 4000K)
- Collimating lens made of optical polymer

3 Front cover

- Polymer, black lacquered

4 Housing

- White (RAL9002), black or silver
- Cast aluminum, powder-coated
- Rotatable through 360° on adapter

5 Control gear

- Trailing edge dimmable+On-board Dim
- Dimming with external dimmers (trailing edge) possible and rotary control for brightness control on the luminaire

6 ERCO turning adapter for 2-circuit track

Variants on request

- Housing: 10,000 further colors
- Please contact your ERCO consultant.



Design and application:
www.erco.com/pantrac

Pantrac for 2-circuit track



Outstanding uniformity
Pantrac provides uniform vertical lighting to perfection - whether in prestigious entrance areas, in offices or in museums.



Simple installation
Pantrac creates perfect light for wallwashing without additional pivoting.

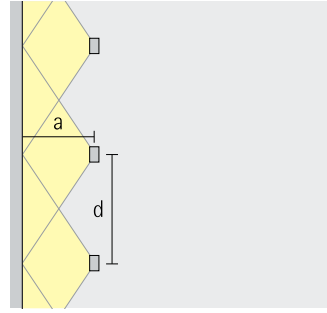

Large luminaire spacing
The high-efficiency Pantrac lighting technology enables luminaire spacing of up to one and a half times the distance to the wall.

Special characteristics

	Outstanding uniformity
	Easy installation
	Wide luminaire spacing with wallwashing



ERCO high-power LEDs



Efficient Spherolit technology



Different light colors



Excellent thermal management



EMC-optimized



Various housing colors



Various construction sizes



Trailing edge dimmable + On-board Dim

Pantrac for 2-circuit track – Luminaire arrangement

Lens wallwashers
Wallwash

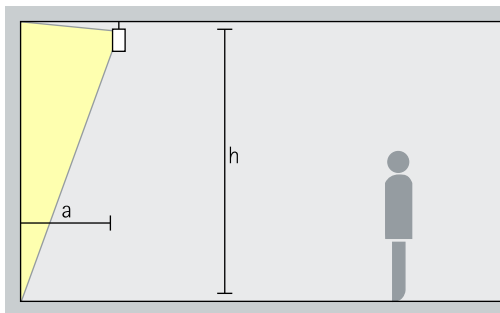

Wallwashing

For uniform vertical illuminance, the distance (a) of Pantrac lens wallwashers from the wall should be around one third of the room height (h). The luminaire head has been adjusted precisely for optimum wallwashing.

Arrangement: $a = 1/3 \times h$

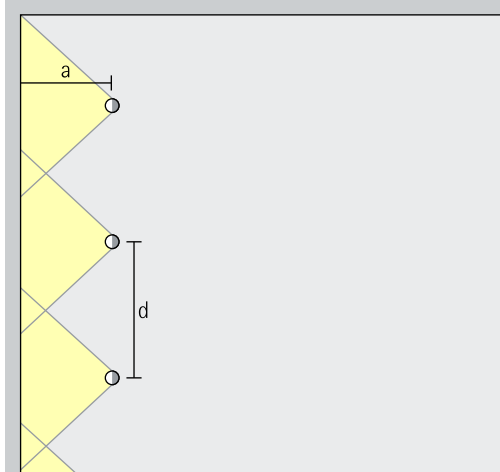

For good longitudinal uniformity, the spacing (d) of Pantrac lens wallwashers may be up to 1.5 times the offset from the wall (a).

Arrangement: $d \leq 1.5 \times a$

The optimal wall offset and luminaire spacing for each product are indicated in the wallwasher tables in the catalogue and the product data sheets.

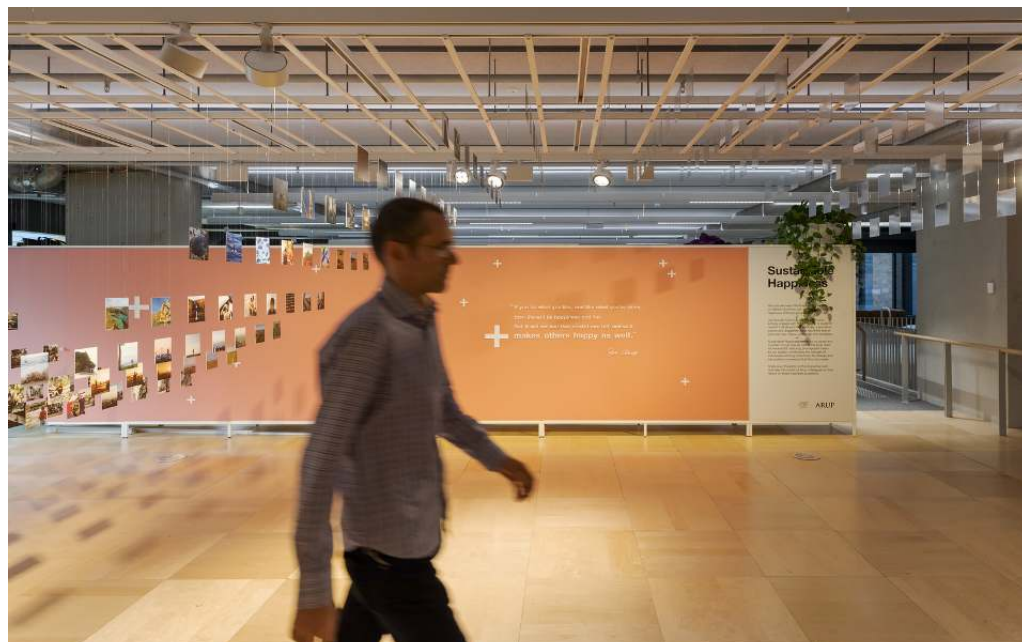

Arup, Sydney.
Lighting design:
Arup. Photography:
Jackie Chan,
Sydney.

Karavaevi Brothers
Cafe – Bolshoy
Levshinskiy
Pereulok. Architec-
ture and lighting
design: V12 Archi-
tects / Vvgeniy
Shchetinkin,
Lleeza Semionova,
Moscow.



Pantrac for 2-circuit track

Construction size 4 3/4"

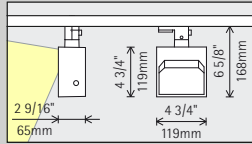

Construction size 8 3/16"

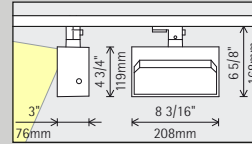

LED module
Maximum value at 4000K CRI 82

12W/1650lm

24W/3300lm

Light color

	2700K CRI 92		3500K CRI 92
	3000K CRI 92		4000K CRI 82
	3000K CRI 97		4000K CRI 92

	2700K CRI 92		3500K CRI 92
	3000K CRI 92		4000K CRI 82
	3000K CRI 97		4000K CRI 92

Light distribution

	Lens wallwashers
	Wallwash

	Lens wallwashers
	Wallwash

Control

Trailing edge dimmable + On-board Dim

Trailing edge dimmable + On-board Dim

Color (housing)

	White		Silver
	Black		10,000 colors *

	White		Silver
	Black		10,000 colors *



IKEA Museum,
Älmhult. Light-
ing design: DHA
Design London.
Mechanical engi-
neering: GMKI
Elkonsult AB
Malmö. Instal-
lation: ELUB AB
Växjö. Photogra-
phy: Johan Elm,
Stockholm.

* available on request

Article numbers and planning data:
www.erco.com/14683-us

Design and application:
www.erco.com/pantrac

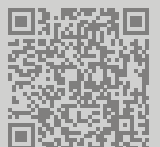



Die Fall der Menschheit
Die Fall der Menschheit ist eine Serie von vier Wandteppichen, die von Pieter Bruegel dem Jüngeren im 16. Jahrhundert geschaffen wurden. Die Serie zeigt die biblische Geschichte der Erschöpfung der Menschheit durch die Sünden der Vorfahren. Die vier Wandteppiche sind: 1. Die Erschöpfung der Menschheit, 2. Die Erschöpfung der Menschheit, 3. Die Erschöpfung der Menschheit, 4. Die Erschöpfung der Menschheit.